

U1LiFePRO™

Battery User Manual



M-12V40-U1
M-24V20-U1



Designed & Manufactured by



Inventus Power, Inc.
1200 Internationale Parkway
Woodridge, IL 60517

inventuspower.com
info@inventuspower.com
+1 877.423.4242

Applicable Models

Model	Part No. (SMBus/CANopen)	Part No. (RS485/CANopen)
M-12V40-U1	57575-101	N/A
M-24V20-U1	N/A	57623-001

Document Information

Release Date	Revision	Scope of Change
2023-02-23	V2.6	Minor edits to version 2 release

Environmental Regulations

The battery pack is compliant with the following environmental regulations:

- EU Directive 2002/95/EC for Restriction of Hazardous Substances (RoHS)
- EU Directive 2006/66/EC on batteries and accumulators and waste batteries and accumulators
- EU Directive 1907/2006 on the Registration Evaluation Authorization and Restriction of Chemicals (REACH)
- Management Methods for Controlling Pollution Caused by Electronic Information Products Regulation (China RoHS)



Please read all contents of this User’s Manual prior to the installation of Inventus Power U1LiFePRO™ Batteries.

DOCUMENT NOTICE: The information contained in this manual is the property of Inventus Power and is subject to change without notice. Inventus Power reserves the right to make changes in the design of its products or components as progress in engineering and manufacturing may warrant. It is the customer’s responsibility to satisfy itself as to whether the information contained herein is adequate and sufficient for a user’s particular use. It is the further responsibility of each user to ensure that all applications of Inventus Power products are appropriate and safe based on conditions anticipated or encountered during use. This document does not create any additional obligation for Inventus Power and does not constitute additional warranties and representations.

Technical Support: For any issues, please email tech_support@inventuspower.com

Inventus Power® and U1LiFePRO™ are trademarks of Inventus Power.

Copyright© 2023 Inventus Power All rights reserved.

Abbreviations

CANOpen	Controller Area Network Bus communication	CCCV	Constant Current Constant Voltage
RS485	Standard type of serial communication protocol	OTC	Over Temperature Charging
SMBus	System Management Bus	OTD	Over Temperature Discharging
OCV	Over Charge Voltage	TCO	Thermal Cutoff
AFE	Analog Front End	SOT	Safety Over Temperature
BMS	Battery Management System	SOC	State of Charge
CC	Constant Current	OCV	Open Circuit Voltage
CID	Current Interrupt Device	RT	Room Temperature
COV	Cell Over Voltage	Ah	Ampere Hour
DOD	Depth of Discharge	CUV	Charge Under Voltage
OCC	Over Current Charge	LED	Light Emitting Diode

Abbreviations	3
Safety Information	5
Personal Protective Equipment / Installation Tools	6
Unboxing the Battery	6
Mechanical Features	7
Battery Serial Number Format	7
Product Dimensions	7
Wake-Up & Ship Mode	8
Selecting Power Cables	9
Communication Cables	9
Selecting a Battery Charger	10
Connecting the Battery	11
Battery Terminal Torque Rating	11
Module Configuration	12
Communications	13
Pin Definition	14
Battery Modes	15
Battery State of Charge Indicator	16
Disconnecting the Battery	17
Battery Specifications	17
Battery Performance Data	18
Maintenance and Storage	19
Transporting Lithium-ion Batteries	20
Emergency and First Aid Procedures	22
Troubleshooting	23
Serial Number Record	24
Warranty Violations	25
Recycling	26
Technical Support	26

DO	DO NOT
<ul style="list-style-type: none"> • Always wear proper personal protective equipment • All installation should be performed by a qualified service technician • Use only insulative tools required for assembly • Dispose of the battery properly in accordance with local, state, and federal regulations • Extinguish any flames with a carbon dioxide, dry- powder fire extinguisher, and cover with copious amounts of water 	<ul style="list-style-type: none"> • Do not use with other types of batteries connected with the PROTRXion™ products • Do not short circuit the battery terminals • Do not operate or store the battery beyond the operating limits • Do not over-charge or over-discharge the battery • Do not crush, puncture, or drop the battery • Do not immerse battery in water • Do not burn or expose battery to fire • Do not charge battery near flammable materials, liquids, and surfaces • Do not alter, disassemble, modify, or open battery • Do not wear jewelry (i.e. rings, watches, bracelets, necklaces) when handling or working near the battery • Do not lift battery by the terminal cables • Do not operate if battery has been damaged in any way during shipping

Symbol	Definition
	Important safety information will follow.
	DO NOT dispose of battery in fire.
	RECYCLE! Battery may require recycling in accordance with local laws. Regardless, recycling is encouraged. Contact local regulatory authorities for more information. DO NOT include battery with lead acid battery recycling.
	DO NOT dispose of battery in the trash.
	Shock Hazard - Labels may be located on or inside the equipment to alert people that dangerous voltage may be present.
	Burn Hazard - Labels may be located on or inside the equipment to alert people that surface temperature may be dangerous.

Personal Protective Equipment / Installation Tools



Before installation or maintenance of your batteries, the following equipment is required:

- Rubber gloves
- Safety goggles or other eye protection
- Insulated Torque Wrench / Philips Screwdriver
- Voltmeter

Unboxing the Battery

Before You Start

Please read all the safety and warranty information provided in this document prior to installing and/or operating the battery.



IMPORTANT: Remove all jewelry or other metallic objects from your hands and body during the installation and removal of the battery packs and peripherals.

What's in the Box?

- Inventus Power U1LiFePRO[™] battery
- UNDOT 38.2 / IATA approved packaging
- QR Code Slip to access manuals, datasheets, and more supporting documents
- Terminal bolts (pre-installed on battery)
- Protective battery terminal covers

Note: All power and signal cables must be purchased separately.

Unpacking

- If possible, do not discard the packaging. This packaging is designed for the safe transportation of lithium-ion batteries compliant with global shipping regulations and can be reused if the battery must be transported to a new location.

Visual Inspection

- Please inspect each battery carefully. Report any damage from shipping to Inventus Power immediately.

Mechanical Features

M-12V40-U1 / M-24V20-U1

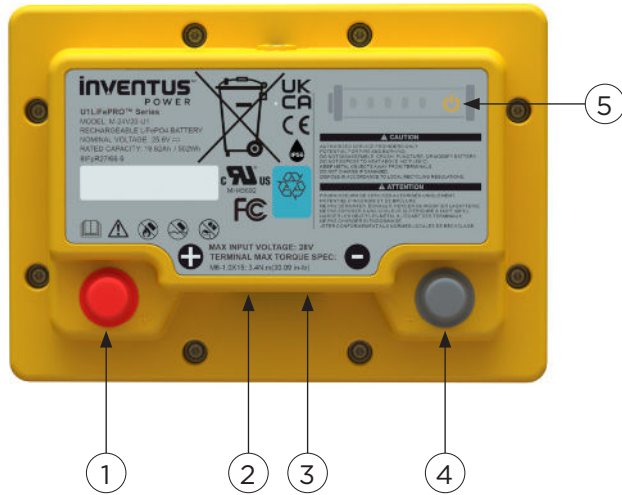

#	Description
1	Positive Terminal
2	Signal Connector #1
3	Signal Connector #2
4	Negative Terminal
5	Battery State of Charge Indicator

Battery Serial Number Format



FF	Factory Location (TJ: Tijuana, Mexico; QX: QingXi, China)
XXXXXXXX	Work Order Number (8 digits)
SSSS	Battery Serial Number (00001-65535)
YYYYMMDD	Mfg Date (Year, Month, and Day)

Product Dimensions

Specification	M-12V40-U1	M-24V40-U1
Length		190±1 mm
Width		132.8±1 mm
Height		183.5±1 mm

Wake-Up & Ship Mode

TO **WAKE UP** THE BATTERY
FROM SHIP MODE

Press the SOC button
for 5 seconds

We recommend to place the battery in Ship Mode when it is not used to prevent self-consumption current drain and extend storage life.

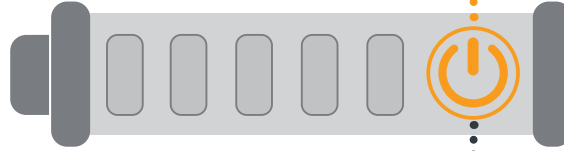

TO PLACE IN **SHIP MODE**

Press the SOC button
for 20 seconds

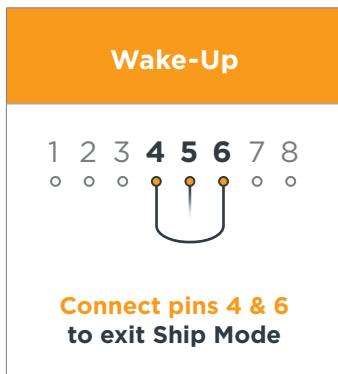

Battery can also receive a wake up signal from the signal connector by shorting pin 6 (VGND) to pin 4 (VINTLK) to wake up battery from Ship Mode.

Selecting Power Cables

Choose the appropriate power cable size based on the system load requirements. Cables are rated for copper conductor at conductor temperatures under 60°C (140°F) per the table below. When connected in parallel configuration, it is preferable for all cables to be the same length and gauge.

Copper Wire Gauge (AWG)	Metric Wire Cross-Section (mm ²)	Ampacity (A)
14	2.08	15
-	2.5	21
12	3.31	20
-	4	26
10	5.26	30
-	6	34
8	8.37	40
-	10	46
6	13.30	55
-	16	61
4	21.15	70
-	25	80
2	33.62	95
-	35	98
1	42.41	110
-	50	121
0 (1/0)	53.46	125
-	70	156
00 (2/0)	67.40	145
-	70	156
000 (3/0)	85.01	165
-	95	187

Communication Cables

If your application requires communication, please use any off-the-shelf cable that is compatible with RIA Connector P/N: AJT3518821-030.

Selecting a Battery Charger

Many types of lead acid chargers are compatible with our U1LiFePRO™ batteries and safely charge between 0°C to 55°C (32°F to 131°F). The charger maximum voltage output should match the maximum charge voltage of the battery system and should not exceed charge voltage as shown in the table below. It is recommended to charge the battery prior to installation. Consult with Inventus Power for recommendation on selecting a battery charger.

After the charger has been selected, first connect the (-) terminal to the battery, then the (+) terminal. Once the terminals have been connected, connect the CAN communication to the battery to optimize the charger performance (preferred chargers recommended by Inventus Power).

Charge Voltage / Current

Model	M-12V40-U1	M-24V20-U1
Max Charge Voltage	14.4 VDC	28.0 VDC
Recommended Charge Current	20A (0.5C)	10A (0.5C)
Maximum Charge Current	40A (1.0C)	20A (1.0C)

Maintenance Charge Voltage Threshold

Battery voltage in which battery charging should activate to maintain full capacity.

Model	M-12V40-U1	M-24V20-U1
Maintenance Charge Voltage	13.4V	26.8V

Charger Current

Max charge current rate will vary depending on ambient temperature and battery state of charge. Charging above the recommended current rate may impact the battery cycle life. For more detailed information on charging profile, please discuss with Inventus Technical Support.

When choosing an intelligent charger, please discuss with Inventus Technical Support on suitable off-the-shelf charger solutions.

Connecting the Battery



CAUTION: Do not connect batteries with reversed battery leads i.e. with the pack positive terminal connected to the source or system negative terminal or the pack negative terminal connected to the source or system positive terminal. Failure to follow proper connection sequence can damage the battery and void the warranty.

1. Remove power to the vehicle/device prior to installation of the U1LiFePRO[™] battery.
2. Remove all other batteries from the system prior to replacing them with U1LiFePRO[™] batteries.
3. Remove the protective battery terminal covers from the terminals. Retain these covers in the event that you need to remove or move the battery at some future time.
4. Attach the negative cable from the device to the negative terminal on the battery.
5. Attach the positive cable from the device to the positive terminal on the battery.
6. Attach the signal communications cable to the RJ45 ports if needed.
7. If the battery charger is integrated with the device drawing power from the U1LiFePRO[™] battery, then please follow manufacturers recommended sequence for each battery connection.
8. It is recommended to fully charge and fully discharge the battery system upon initial connection to properly calibrate the SOC.
9. Please contact Inventus Technical Support if the system requires more than 10 batteries.

Battery Terminal Torque Rating

Model	Terminal Type	Wrench Size	Torque (Nm)
M-12V40-U1 M-24V20-U1	ISO M6 x 1.0 x 16mm Bolt	10mm	3.4 ± 0.5 Nm

Feed terminal bolt (A) through lock washer (B), then flat washer (C), followed by power cable ring terminal (D) before threading into battery terminal as shown in the image to the right.

CAUTION: When using bolts to engage the battery's threaded holes, use the appropriate number of flat and lock washers to allow for as much thread engagement as possible without bottoming out the bolt. Over-tightening battery terminal bolts could result in damage to battery terminals. Under-tightening battery terminals could result in excessive heating of the terminals.

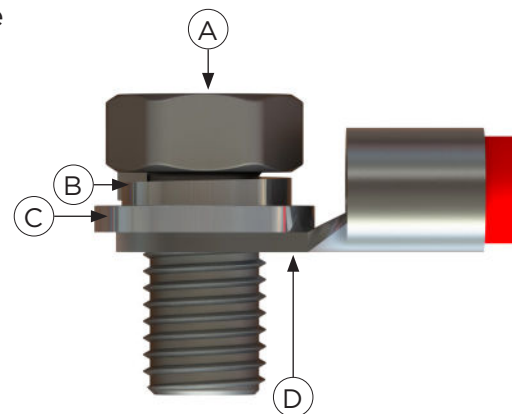



Warning: Do not connect batteries in series. Connecting in series exceeds the voltage limit of the integrated safety protection circuitry and can damage the battery and void the warranty.

Parallel connections

Two or more batteries can be connected together in parallel to increase the capacity of the battery system. The negative terminal of the first battery is connected via jumper cable to the negative terminal of the second battery. Use another set of jumper cables with the same wire gauge to connect the positive terminals of both batteries together. Connect a signal cable from one signal port to another. This connection process can be repeated to up to the max scalability or until the desired capacity is reached. Finally, use another set of power cables with the same wire gauge to connect the positive terminal from the first battery and the negative terminal from the last battery in the parallel chain to the host system. This will ensure proper balancing of the system. See parallel connection diagram below.

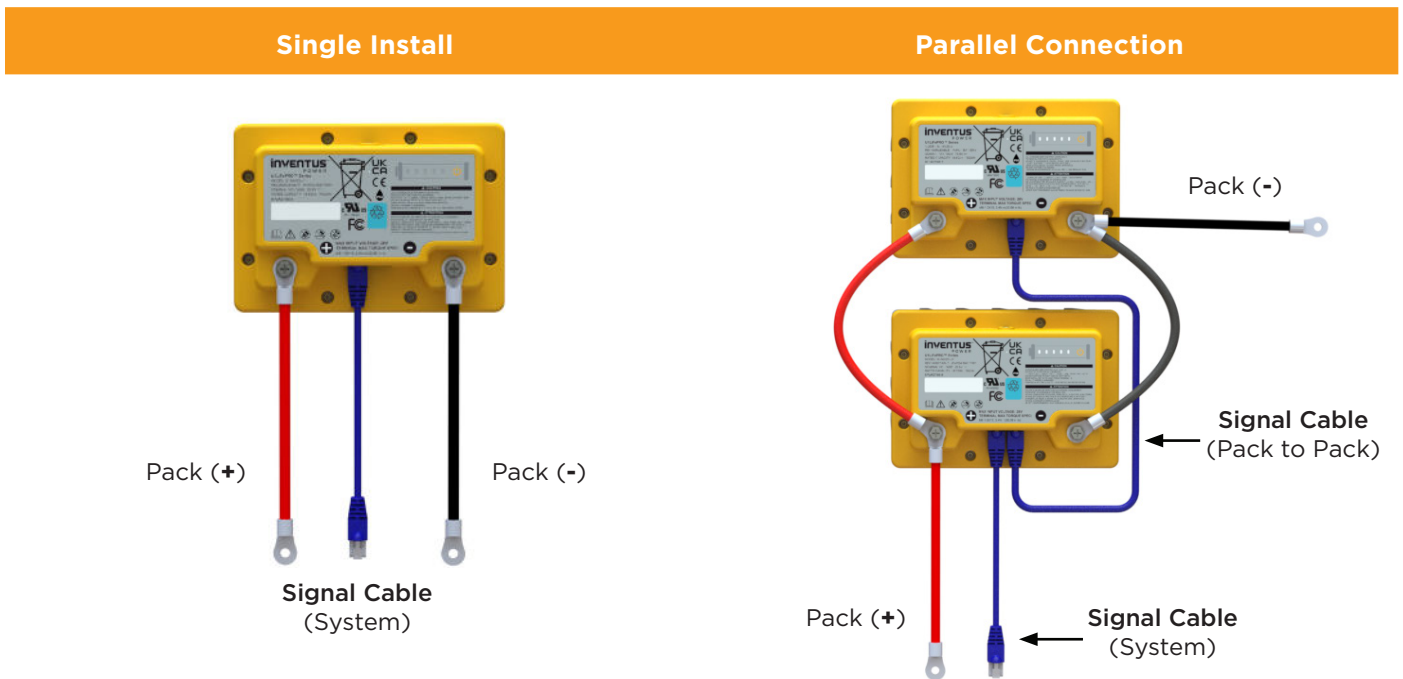

Note: CAN lines in the battery pack DO NOT have internal termination resistance. It is recommended to properly terminate the system and battery CAN Bus lines following the CAN Bus termination standards. For any technical questions about properly adding termination resistance, please contact technical support at tech_support@inventuspower.com.

- Each U1LiFePRO[™] battery uses two RJ45 connectors to support signal communication with the host system.
- Communications are disabled until the battery is awakened by the charger applying a charge voltage.
- Voltage, current, temperature, capacity, cycle count, state of charge, and fault codes can be read from the battery using SMBus, RS485, or CANopen communication.
- A signal interface is used as the communication interface between the battery and a connected device.



Warning: Do not connect signal ground (pin 6) to battery pack terminal ground (-). Connecting the signal ground improperly can damage the battery and void the warranty.

Pin Definition

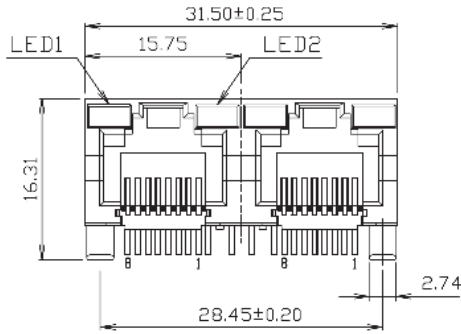

RIA Connector P/N: AJT3518821-030

If in doubt, please consult with **Inventus Power Technical Support** (tech_support@inventuspower.com) on further instructions on the signal cable connections to the host system.

Pin Definition (M-12V40-U1)

Pin #	Symbol	Description
1	SMBUS	SMBDAT; leave floating when using CAN
2	SMBUS	SMBCLK; leave floating when using CAN
3		<i>not used</i>
4	VINTLK	For charging, connect VGND to VINTLK
5	VWAKE	For discharging, connect VGND to VWAKE
6	VGND	Ground Reference
7	VCANH_BATT	CAN High (Battery)
8	VCANL_BATT	CAN Low (Battery)

Pin Definition (M-24V20-U1)

Pin #	Symbol	Description
1	A-RS485	RS485 Data A; leave floating when using CAN
2	B-RS485	RS485 Data B; leave floating when using CAN
3		<i>not used</i>
4	VINTLK	For charging, connect VGND to VINTLK
5	VWAKE	For discharging, connect VGND to VWAKE
6	VGND	Ground reference
7	VCANH_BATT	CAN High (Battery)
8	VCANL_BATT	CAN Low (Battery)

Battery Modes

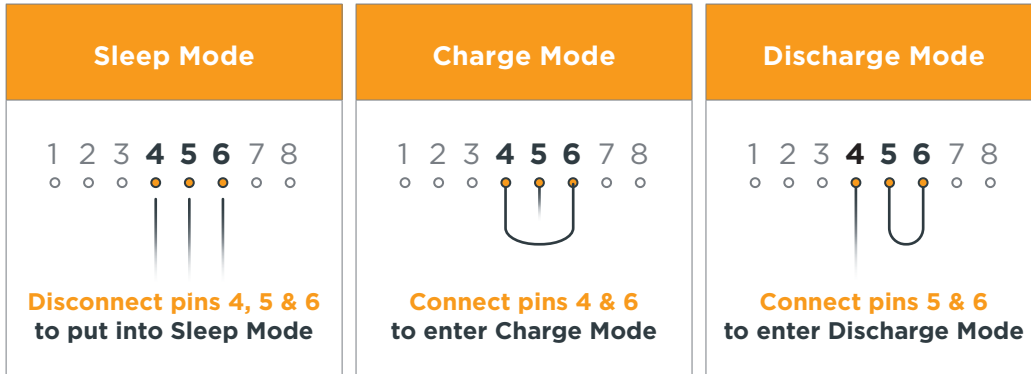

Mode Name	VWAKE	VINTLK	Action	Mode Description
Sleep	Off (Open)	Off (Open)	Disconnect pins 4, 5, and 6 to enter Sleep Mode	Low power mode, MOSFETs open
Charge	Off (Open)	On (Low)	Connect pins 4 and 6 to enable charging	Charge allowed*, MOSFETs closed
Charge	On (Low)	On (Low)	Connect pin 6 to pins 4 and 5 to enable charging	Charge allowed*, MOSFETs closed
Discharge	On (Low)	Off (Open)	Connect pins 5 and 6 to allow discharging	Discharge allowed**, MOSFETs closed
Ship	Off (Open))	N/A	Press the SOC button and hold for 20 sec	Low power mode, MOSFETs open
Shutdown	N/A	N/A	Apply charge voltage to exit Shutdown	Lowest power mode, MOSFETs open

*Discharge also allowed in this mode unless discharge fault condition is detected in which case discharge MOSFETs are opened.

**Charge also allowed in this mode unless charge fault condition is detected in which case charge MOSFETs are opened.

Wake from Shutdown Mode





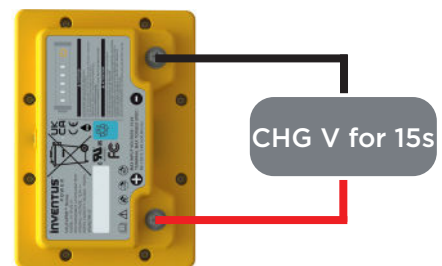

To exit Shutdown Mode, apply battery charge voltage pulse to the positive and negative terminals for >15 seconds.

Note: Many intelligent chargers sense voltage at the battery terminals prior to applying charge voltage and thus will not wake the battery from Shutdown Mode. In this case, it is recommended to use a power supply set to the appropriate charge voltage to wake the battery from Shutdown Mode.



Battery State of Charge Indicator

There are (5) LEDs and one button on each module to be used for SOC and fault indication. To the far right is the button followed by the LEDs to the left as shown in the figure below. The LEDs will be capable of representing a range for the remaining SOC. The LEDs will remain lit for 5 seconds after the button is pressed before turning off unless the SOC is 10% or less, then the first LED will blink on and off for 10 seconds. The LEDs will come on when the following conditions are detected:

LED Indicator Status	Battery State of Charge
	81 - 100%
	61 - 80%
	41 - 60%
	21 - 40%
	11 - 20%
	1 to 10%

Disconnecting the Battery



CAUTION: Failure to follow proper disconnection sequence can damage the battery and void the warranty.

1. Power off the machine/device prior to the removal of the U1LiFePRO™ battery.
2. If the battery charger is integrated with the device drawing power from the U1LiFePRO™ battery, then please follow manufacturers recommended sequence for battery disconnect.
3. Disconnect the communications cable from the RJ45 port if one is attached.
4. Disconnect the positive cable from the positive terminal on the battery.
5. Disconnect the negative cable from the negative terminal on the battery.

Battery Specifications

Specification	M-12V40-U1	M-24V20-U1
Cell Chemistry	Lithium Iron Phosphate	
Voltage (Nominal / Max Charge)	12.8V / 14.4V	25.6V / 28V
Energy	510Wh / 39Ah	502Wh / 20Ah
Continuous Discharge Current (per module)	0.51kW / 40A	0.77kW / 30A
Peak Pulse Discharge (@ 25°C)	80 Amps < 10secs	60 Amps < 10secs
Cycle Life (@ 25°C)	3,000 @ 80% DoD	3,000 @ 80% DoD
Charge Operating Temperature	0°C to +55°C	
Discharge Operating Temperature	-20°C to +60°C	
Operating Humidity	5% to 95%	
Scalability	Parallel: 10 max	Parallel: 10 max
Weight (max)	6.5kg (14.3lbs)	6.5kg (14.3lbs)
Communication	SMBus / CANopen	RS485 / CANopen
Certifications	UN38.3, FCC Class B, UL1642, UL2054 IEC62133, CE, RoHS, WEEE	

Battery Performance Data

M-12V40-U1 Charging Performance

Test Condition: Ambient Temperature

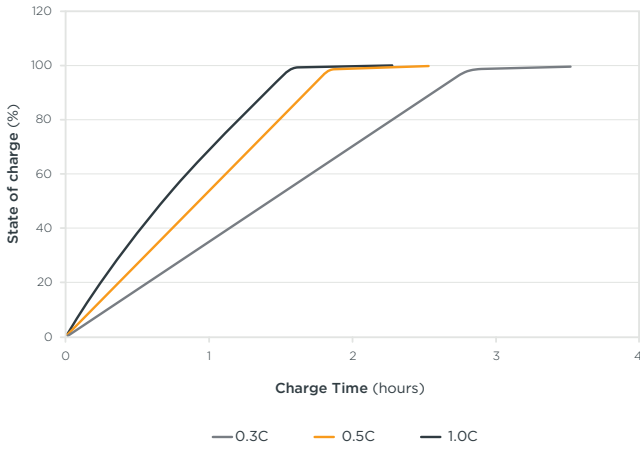

M-12V40-U1 Capacity vs Discharge Rate

Test Condition: Ambient Temperature

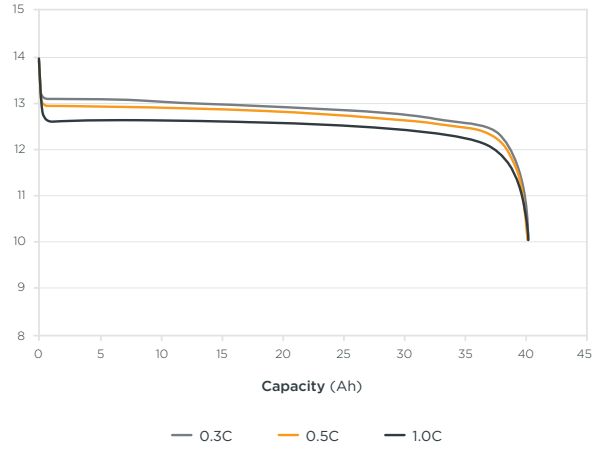

M-24V20-U1 Charging Performance

Test Condition: Ambient Temperature

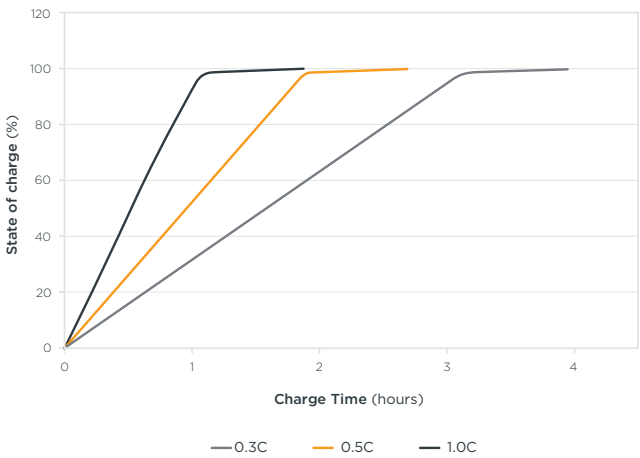

M-24V20-U1 Capacity vs Discharge Rate

Test Condition: Ambient Temperature

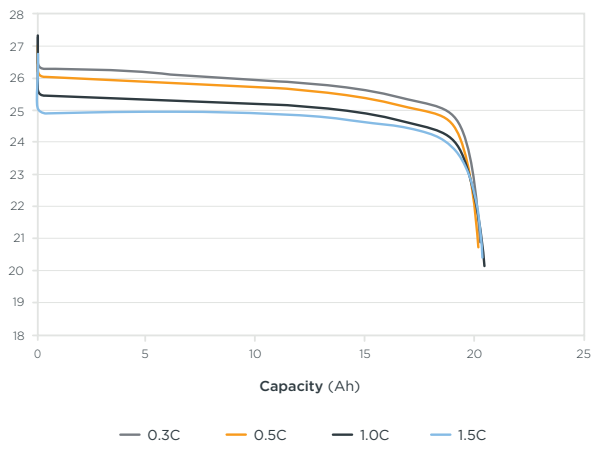

Calibration Cycle

It is recommended to charge the battery to 100% SOC after installation. A full charge and discharge cycle is recommended at least every 6 to 12 months to maintain proper SOC calibration and cell balancing.

Maintenance Charging

U1LiFePRO™ batteries can be stored in an environment with temperatures between -20°C (-4°F) and +60°C (140°F) and between 5% and 95% relative humidity, non-condensing. For long storage periods it is recommended to check the battery SOC every 6 months. If batteries are stored at 25°C (77°F), charge the battery every 9 months. For storage temperatures above 25°C (77°F), charge the battery every 6 months. It is recommended to charge the batteries when SOC falls below 10%. If longer storage time between charging is desired, place the battery into Shutdown Mode.

Battery Case Visual Inspection

Please perform regular visual inspections of the battery case. If the battery case is found to have dents, discoloration, or appears to be damaged in any way, DISCONTINUE USE IMMEDIATELY. Please contact Inventus Power for assistance with evaluating the product for continued usability.

Voltage Checking

The voltage of the battery can be monitored during normal operation or as part of standard tests performed periodically to assess the health of the battery. If you find the battery voltage under 20V at room temperature, the battery has been over-discharged or is self-discharging due to some defect/parasitic load. Discontinue use until the fault can be corrected and the battery can be recharged.

Battery Storage

- Battery should be stored between 30-50% SOC.
- Store in an open, well ventilated, and dry area <30°C for maximum life.
- Do not expose the battery to extreme temperature or sunlight over 60°C (140°F).
- Do not expose the battery to direct sunlight or moisture and/or precipitation.
- Handle each battery carefully to avoid sharp impacts or extreme pressure on the case.
- Do not store a fully discharged battery. Recharge battery after every use.

Minimum Temperature	Maximum Temperature	Duration
-20°C (-4°F)	45°C (113°F)	1 month
-20°C (-4°F)	35°C (95°F)	3 months
-20°C (-4°F)	25°C (77°F)	9 months
		24 months (In Shutdown Mode)

This section discusses the regulations governing the transportation of lithium-ion cells and batteries both within the United States and internationally. You should read and understand all relevant regulations discussed in this section before shipping Inventus Power U1LiFePRO™ batteries.

Lithium batteries are classified as Class 9 when transporting by air or ground. When shipping by air, all lithium batteries are required to have a 30% state of charge or less. Lithium batteries with capacity greater than 300 Wh and exceed 30kg (66lbs), are considered Class 9 when shipping by ground. For more information on shipping Lithium Batteries, please see your freight carrier's requirements.

NOTE: The regulations discussed in this manual apply to lithium-ion cells and batteries. Once the Inventus Power U1LiFePRO™ battery is integrated into a host system, the host may be subject to additional transportation regulations that require additional certification testing. Since Inventus Power cannot anticipate every possible configuration and application of the U1LiFePRO™ you must verify that your U1LiFePRO™ powered host product is compliant with all local ordinances and regulations.

Transporting Batteries for Installation

- Place the battery terminal protective caps on the battery terminals prior to removing the battery from its current location, to prevent accidental shorts or arcing from occurring if a terminal touches a metal object.
- Battery handle must be in the close position prior to assembly.
- Avoid heavy vibration during transportation.
- Avoid throwing, dropping, rolling and excessive stacking during loading and transportation.
- Make sure that all cables and external connectors are disconnected and properly removed from the battery prior to transporting it.
- Do not hang or hook battery handle with sharp device or at one corner only.

Transporting Batteries to a Different Location

If the battery needs to be shipped to a different location or sent back to Inventus Power for any reason:

1. Disconnect all cables, both power and communications from the batteries.
(reference section "Disconnecting the Battery" for proper disconnection procedure)
2. Place the protective caps on the battery terminals prior to removing the battery from its current location, to prevent accidental shorts or arcing from occurring if a terminal touches a metal object.
3. All large lithium-ion batteries are considered "Dangerous Goods" by the US Department of Transportation, and as a result, transporting them by common carrier (whether by ground or by air) requires compliance with UN DOT regulations UN3480, Class 9 - "Dangerous Goods".
4. Pack the batteries in "Dangerous Goods" certified boxes and packaging materials as specified by the Department of Transportation (DOT). The packaging must protect the contents from reasonable handling damage and prevent short circuits from taking place. Ideally, one would use the original box if it's still in good condition.
5. The package should be prepared for shipment and shipping documents should be signed by an individual who is certified to handle and prepare the paperwork and products that have been designated as "Dangerous Goods" for shipment.



IMPORTANT: The U1LiFePRO™ battery is shipped in a specially designed box to provide maximum protection for the contents. We strongly recommend that you save this box and use it whenever you need to transport or ship the battery. Please follow all local laws/regulations regarding the shipment of lithium-ion batteries.

Following UN and DOT Regulations

Failure to comply with UN and DOT regulations while transporting Class 9 Hazardous Materials (Dangerous Goods) may result in substantial civil and criminal penalties.

Emergency Procedures for a Smoking Battery

- If a battery begins to smoke or melt, remove charging source immediately.
- If possible, move the battery to a well-ventilated area, preferably outside.
- Submerge in water or douse with copious amounts of water.

First Aid Procedures for Human Contact/Exposure to Battery Content

In the event of exposure to battery contents, the following could occur:

- Vapor or mist could irritate eyes, mucous membranes and/or respiratory tract
- Irritation to eyes and skin
- Exposure can cause nausea, dizziness or headache.

In case of contact with the battery's electrolyte:

- Immediately flush eyes with copious amounts of water for at least 15 minutes
- Assure adequate flushing of the eyes by separating the eyelids with fingers
- Flush skin with water
- Remove and wash contaminated clothing promptly
- If inhaled, remove oneself to fresh air
- If swallowed, wash out mouth with water
- If not breathing or having difficulty breathing, seek first aid

Despite the high reliability of the U1LiFePRO™ battery, you may encounter situations where the battery module does not operate as expected. These situations are typically the result of misuse, abuse or a non-optimal operating or storage environment. If the battery is not operating correctly, you will need to perform the following troubleshooting procedures to fix the issue.

Fault ID	LED Status	Description of Fault	Fix
F0		Over-temperature (cells)	Wait for temperature to drop into acceptable operating range
F1		Over-temperature (BMS)	Wait for temperature to drop into acceptable operating range
F2		Under-temperature (charge)	Wait for temperature to drop into acceptable operating range
F3		Over-current (recoverable)	If charging, power cycle charger; replace charger if problem persists. If discharging, battery will resume operation after discharge has been stopped.
F4		Over-current (permanent fault)	Disconnect and replace battery.
F5		Short-circuit	Check all connection point to battery system.
F6		Cell under-voltage during discharge only	Recharge battery.
F7		Cell over-voltage during charge only (primary)	Discharge battery down to 20% SOC and then recharge battery.
F8		Cell over-voltage during charge only (secondary)	Disconnect and replace battery.
F9		Safety under-voltage	Recharge battery.
F10		Cell pre-charge fault	Power cycle charger and replace charger if problem persists
F11		Charge fault	Power cycle charger and replace charger if problem persists.
F12		Under-temperature (discharge)	Wait for temperature to rise into acceptable operational range.
F13		Miscellaneous fault	Power cycle battery. Replace battery if problem persists
F14		Pre-discharge	Enable the battery without load and check if fault goes away. If fault is not present, reconnect to system. If fault persists, disconnect and replace battery.
F15		Permanent fault	Disconnect and replace battery.

Serial Number Record



Please record both the serial number and date of purchase and store this in a safe place for future reference.

Serial Number		Date of Purchase	
Serial Number		Date of Purchase	
Serial Number		Date of Purchase	
Serial Number		Date of Purchase	
Serial Number		Date of Purchase	
Serial Number		Date of Purchase	
Serial Number		Date of Purchase	
Serial Number		Date of Purchase	
Serial Number		Date of Purchase	
Serial Number		Date of Purchase	
Serial Number		Date of Purchase	
Serial Number		Date of Purchase	
Serial Number		Date of Purchase	
Serial Number		Date of Purchase	
Serial Number		Date of Purchase	
Serial Number		Date of Purchase	
Serial Number		Date of Purchase	
Serial Number		Date of Purchase	
Serial Number		Date of Purchase	



CAUTION: Performing any of the following actions will immediately void your warranty on the product and could lead to a potentially dangerous situation

1. Breaking the lid and exposing the circuit boards and battery assemblies.
2. Incorrect battery wiring and/or installation. Verify polarity at all connections with a standard voltmeter
3. Operating the battery in an environment where the temperature exceeds the specified limits.
4. Modifying or tampering with the M6 power terminals, RJ45 connector, communication interface, and internal data logging functions
5. Incorrect battery bank sizing.
6. Verify polarity at all connections with a standard voltmeter (1) before energizing the system and (2) on batteries with threaded connections, before switching the built-in circuit breaker to the “ON” position.
7. Pairing the battery with incompatible equipment. Use of accessories not recommended or sold by the manufacturer may result in a risk of fire, electric shock, or injury to persons and will Void the Warranty.
8. Exceeding the maximum continuous discharge rate or charge rate can damage and void the U1LiFePRO™ battery.

Inventus does NOT cover product damage caused by mishandling or improper use per the Installation Manual, Integration Guides and Warranty, exposure to liquids, impacts from falling objects or being dropped, or attempts to repair the battery by any party other than Inventus.

The complete list of Warranty Exclusions is included in the Inventus Power Battery Warranty document:

If you believe that in the course of using the U1LiFePRO™ battery, you will conflict with any of the above listed conditions or any other safety precautions listed in this manual, please DO NOT proceed any further.

Contact Inventus Power immediately for guidance and information.

Recycling



Inventus Power batteries are recyclable and should be disposed properly. For information about recycling, please visit our website at: www.inventuspower.com/recycling/

Technical Support

If you have any technical questions regarding the U1LiFePRO™ battery, please contact our service support team at:

Phone: +1.877.423.4242

E-mail: tech_support@inventuspower.com